



Designation: D4595/D4595M – 23

Standard Test Method for Tensile Properties of Geotextiles by the Wide-Width Method¹

This standard is issued under the fixed designation D4595/D4595M; the number immediately following the designation indicates the year of original adoption or, in the case of revision, the year of last revision. A number in parentheses indicates the year of last reapproval. A superscript epsilon (ϵ) indicates an editorial change since the last revision or reapproval.

1. Scope

1.1 This test method covers the measurement of tensile properties of geotextiles using a wide-width strip specimen tensile method. This test method is applicable to most geotextiles that include woven fabrics, nonwoven fabrics, layered fabrics, knit fabrics, and felts that are used for geotextile application.

1.2 This test method covers the measurement of tensile strength and elongation of geotextiles and includes directions for the calculation of initial modulus, offset modulus, secant modulus, and breaking toughness.

1.3 Procedures for measuring the tensile properties of both conditioned and wet geotextiles by the wide-width strip method are included.

1.4 The basic distinction between this test method and other methods for measuring strip tensile properties is the width of the specimen. Some fabrics used in geotextile applications have a tendency to contract (neck down) under a force in the gage length area. The greater width of the specimen specified in this test method minimizes the contraction effect of those fabrics and provides a closer relationship to expected geotextile behavior in the field and a standard comparison.

1.5 The values stated in either SI units or inch-pound units are to be regarded separately as standard. The values stated in each system may not be exact equivalents; therefore, each system shall be used independently of the other. Combining values from the two systems may result in nonconformance with the standard.

1.6 *This standard does not purport to address all of the safety concerns, if any, associated with its use. It is the responsibility of the user of this standard to establish appropriate safety, health, and environmental practices and determine the applicability of regulatory limitations prior to use.*

1.7 *This international standard was developed in accordance with internationally recognized principles on standardization established in the Decision on Principles for the*

Development of International Standards, Guides and Recommendations issued by the World Trade Organization Technical Barriers to Trade (TBT) Committee.

2. Referenced Documents

2.1 *ASTM Standards:*²

[D76/D76M Specification for Tensile Testing Machines for Textiles](#)

[D123 Terminology Relating to Textiles](#)

[D579/D579M Specification for Greige Woven Glass Fabrics](#)

[D1776/D1776M Practice for Conditioning and Testing Textiles](#)

[D2905 Practice for Statements on Number of Specimens for Textiles \(Withdrawn 2008\)](#)³

[D4439 Terminology for Geosynthetics](#)

3. Terminology

3.1 *atmosphere for testing geotextiles, n*—air maintained at a relative humidity of $65 \pm 5\%$ and a temperature of $21 \pm 2^\circ\text{C}$ [$70 \pm 4^\circ\text{F}$].

3.2 *breaking toughness, T, (FL⁻¹), Jm⁻², n*—for geotextiles, the actual work-to-break per unit surface area of material.

3.2.1 *Discussion*—Breaking toughness is proportional to the area under the force-elongation curve from the origin to the breaking point (see also work-to-break). Breaking toughness is calculated from work-to-break, gage length, and width of a specimen.

3.3 *corresponding force, F_c, n*—the force associated with a specific elongation on the force-per-unit-width strain curve. (Syn. load at specified elongation, LASE.)

3.4 *geotechnical engineering, n*—the engineering application of geotechnics.

3.5 *geotechnics, n*—the application of scientific methods and engineering principles to the acquisition, interpretation, and use of knowledge of materials of the earth's crust to the solution of engineering problems.

¹ This test method is under the jurisdiction of ASTM Committee D35 on Geosynthetics and is the direct responsibility of Subcommittee D35.01 on Mechanical Properties.

Current edition approved April 15, 2023. Published May 2023. Originally approved in 1986. Last previous edition approved in 2017 as D4595 – 17. DOI: 10.1520/D4595_D4595M-23.

² For referenced ASTM standards, visit the ASTM website, www.astm.org, or contact ASTM Customer Service at service@astm.org. For *Annual Book of ASTM Standards* volume information, refer to the standard's Document Summary page on the ASTM website.

³ The last approved version of this historical standard is referenced on www.astm.org.

3.5.1 *Discussion*—Geotechnics embraces the fields of soil mechanics, rock mechanics, and many of the engineering aspects of geology, geophysics, hydrology, and related sciences.

3.6 *geotextile, n*—any permeable textile material used with foundation, soil, rock, earth, or any other geotechnical engineering related material, as an integral part of a man-made project, structure, or system.

3.7 *initial tensile modulus, J_i , (FL^{-1}), Nm^{-1} , n*—for *geotextiles*, the ratio of the change in tensile force per unit width to a change in strain (slope) of the initial portion of a force-per-unit-width strain curve.

3.8 *offset tensile modulus, J_o , (FL^{-1}), Nm^{-1} , n*—for *geotextiles*, the ratio of the change in force per unit width to a change in strain (slope) below the proportional limit point and above the tangent point on the force-elongation curve.

3.9 *proportional limit, n*—the greatest stress which a material is capable of sustaining without any deviation from proportionality of stress to strain (Hooke’s law).

3.10 *secant tensile modulus, J_{sec} , (FL^{-1}), Nm^{-1} , n*—for *geotextiles*, the ratio of change in force per unit width to a change in strain (slope) between two points on a force-per-unit-width strain curve.

3.11 *tangent point, n*—for *geotextiles*, the first point of the force-elongation curve at which a major decrease in slope occurs.

3.11.1 *Discussion*—The tangent point is determined by drawing a tangent line passing through the zero axis and the proportional elastic limit. The point from the zero-force axis that the force-elongation curve first touches that tangent line is the tangent point.

3.12 *tensile modulus, J , (FL^{-1}), Nm^{-1} , n*—for *geotextiles*, the ratio of the change in tensile force per unit width to a corresponding change in strain (slope).

3.13 *tensile strength, n*—for *geotextiles*, the maximum resistance to deformation developed for a specific material when subjected to tension by an external force.

3.13.1 *Discussion*—Tensile strength of geotextiles is the characteristic of a sample as distinct from a specimen and is expressed as force per unit width.

3.14 *tensile test, n*—in *textiles*, a test in which a textile material is stretched in one direction to determine the force-elongation characteristics, the breaking force, or the breaking elongation.

3.15 *wide-width strip tensile test, n*—for *geotextiles*, a uniaxial tensile test in which the entire width of a 200 mm [8.0 in.] wide specimen is gripped in the clamps and the gage length is 100 mm [4.0 in.].

3.16 *work-to-break, W , (LF), n*—in *tensile testing*, the total energy required to rupture a specimen.

3.16.1 *Discussion*—For *geotextiles*, work-to-break is proportional to the area under the force-elongation curve from the origin to the breaking point, and is commonly expressed in joules [inch-pound force].

3.17 *yield point, n*—the first point of the force-elongation curve above the proportional (linear) section at which an increase in elongation occurs without a corresponding increase in force.

3.18 For terminology of other terms used in this test method, refer to Terminology **D123** and Terminology **D4439**.

4. Summary of Test Method

4.1 A relatively wide specimen is gripped across its entire width in the clamps of a constant rate of extension (CRE) type tensile testing machine operated at a prescribed rate of extension, applying a longitudinal force to the specimen until the specimen ruptures. Tensile strength, elongation, initial and secant modulus, and breaking toughness of the test specimen can be calculated from machine scales, dials, recording charts, or an interfaced computer.

5. Significance and Use

5.1 The determination of the wide-width strip force-elongation properties of geotextiles provides design parameters for reinforcement type applications, for example design of reinforced embankments over soft subgrades, reinforced soil retaining walls, and reinforcement of slopes. When strength is not necessarily a design consideration, an alternative test method may be used for acceptance testing. Test Method D4595/D4595M for the determination of the wide-width strip tensile properties of geotextiles may be used for the acceptance testing of commercial shipments of geotextiles, but caution is advised since information about between-laboratory precision is incomplete (**Note 6**). Comparative tests as directed in **5.1.1** may be advisable.

5.1.1 In cases of a dispute arising from differences in reported test results when using Test Method D4595/D4595M for acceptance testing of commercial shipments, the purchaser and the supplier should conduct comparative tests to determine if there is a statistical bias between their laboratories. Competent statistical assistance is recommended for the investigation of bias. At a minimum, the two parties should take a group of test specimens which are as homogeneous as possible and which are from a lot of material of the type in question. The test specimens should then be randomly assigned in equal numbers to each laboratory for testing. The average results from the two laboratories should be compared using Student’s *t*-test for unpaired data and an acceptable probability level chosen by the two parties before the testing began. If a bias is found, either its cause must be found and corrected or the purchaser and the supplier must agree to interpret future test results in light of the known bias.

5.2 Most geotextiles can be tested by this test method. Some modification of clamping techniques may be necessary for a given geotextile depending upon its structure. Special clamping adaptations may be necessary with strong geotextiles or geotextiles made from glass fibers to prevent them from slipping in the clamps or being damaged as a result of being gripped in the clamps. Specimen clamping may be modified as required at the discretion of the individual laboratory, provided a representative tensile strength is obtained. In any event, the



a. Wedge clamps



b. Curtis "Geo-Grips"

FIG. 1 Wedge Clamps

procedure described in Section 10 of this test method for obtaining wide-width strip tensile strength must be maintained.

5.3 This test method is applicable for testing geotextiles either dry or wet. It is used with a constant-rate-of-extension type tension apparatus.

5.4 The use of tensile strength test methods that restrict the *clamped* width dimension to 50 mm [2 in.] or less, such as the ravel, cut strip, and grab test procedures, have been found less suitable than this test method for determining design strength parameters for some geotextiles. This is particularly the case for nonwoven geotextiles. The wide-width strip technique has been explored by the industry and is recommended in these cases for geotextile applications.

5.4.1 This test method may not be suited for some woven fabrics used in geotextile applications that exhibit strengths approximately 100 kN/m or 600 lbf/in. due to clamping and equipment limitations. In those cases, 100 mm [4 in.] width specimens may be substituted for 200 mm [8 in.] width specimens. On those fabrics, the contraction effect cited in 1.4 is minimal and, consequently, the standard comparison can continue to be made.

6. Apparatus and Reagents

6.1 *Tensile Testing Machine*—A constant rate of extension (CRE) type of testing machine described in Specification D76/D76M shall be used. When using the CRE-type tensile tester, the recorder must have adequate pen response to properly record the force-elongation curve as specified in Specification D76/D76M.

6.2 *Clamps*—The clamps shall be sufficiently wide to grip the entire width of the sample and with appropriate clamping power to prevent slipping or crushing (damage).

6.2.1 There are several types of clamp designs available. Three basic clamp design examples are shown in Figs. 1-3.

These designs have been used in the laboratory and have provided reproducible tensile strengths. These clamps may be modified to provide greater ease and speed of clamping. In any event, caution must be taken to ensure the type material and dimensions of the clamp are adequate for the user's expected fabric strength. Additional guidance is given in Appendix X5.

6.2.2 *Size of Jaw Faces*—Each clamp shall have jaw faces measuring wider than the width of the specimen, 200 mm [8 in.], and a minimum of 50 mm [2 in.] length in the direction of the applied force.

6.3 External extensometers or other external means of measurement are required for all tests where modulus is to be measured. The clamping mechanism and weight of the extensometer shall not affect the tensile performance of the geotextile, such as breaks occurring or initiating at the extensometer clamp. In this case, the distance between the moving feet of the extensometer determines the gage length for use in elongation calculations and not test speed. Examples of contact and noncontact extensometers are shown in Figs. 5-7. Please see Note 6 and Appendix X5.

6.4 *Area-Measuring Device*—Use an integrating accessory to the tensile testing machine or a planimeter.

6.5 *Distilled Water and Nonionic Wetting Agent*, for wet specimens only.

7. Sampling

7.1 *Lot Sample*—For the lot sample, take rolls of geotextiles as directed in an applicable material specification, or as agreed upon between the purchaser and the supplier.

NOTE 1—The extent of the sampling for wide-width strip tensile properties is generally defined in an applicable order or contract. Among the options available to the purchaser and the supplier is for the purchaser to accept certification by the manufacturer that the material in question meets the requirements agreed upon by the two parties, and what the basis

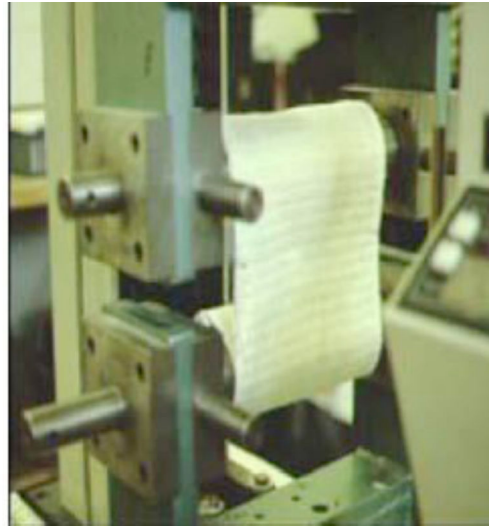
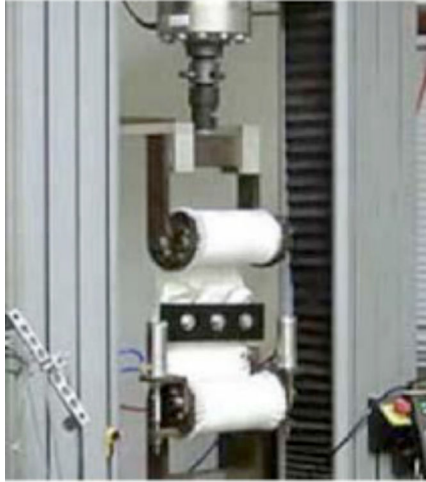

a. Capstan Clamps

b. Roller Grips

FIG. 2 Inserts for Wedge Clamps

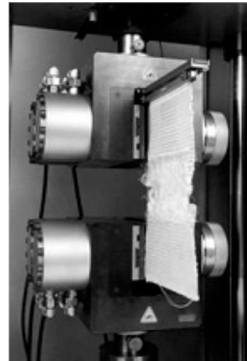

FIG. 3 Roller Clamps

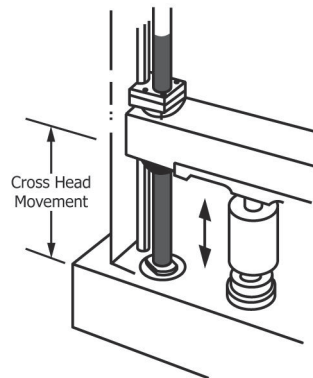

FIG. 4 End View of Composite of Clamp, Insert, and Threaded Rod

for the certification is, such as, historical data generated from material manufactured under the same conditions.



a. Photograph of Clip-On Extensometer



b. Photograph of Cable "Roller Style" Extensometer

FIG. 5 Sanders Clamp



a. Photograph of Video Extensometer



b. Photograph of Infra-Red Extensometer

FIG. 6 Noncontact Extensometer

7.2 *Laboratory Sample*—For the laboratory sample, take a full-width swatch from each roll in the lot sample. The sample may be taken from the end portion of a roll, provided there is no evidence it is distorted or different from other portions of the roll. In cases of dispute, take a sample that will exclude fabric from the outer wrap of the roll or the inner wrap around the core.

7.3 *Test Specimens*—For tests in the machine direction and the cross-machine direction, respectively, take from each swatch in the laboratory sample the number of specimens directed in Section 8. Take specimens at random from the laboratory sample, with those for the measurement of the machine direction tensile properties from different positions across the geotextile width, and the specimens for the measurement of the cross-machine direction tensile properties from

different positions along the length of the geotextile. Take no specimens nearer the selvage or edge of the geotextile than one tenth the width of the geotextile (see 8.2).

8. Test Specimen Preparation

8.1 *Number of Specimens:*

8.1.1 Unless otherwise agreed upon, as when specified in an applicable material specification, take a number of specimens per fabric swatch such that the user may expect at the 95 % probability level that the test result is not more than 5.0 % of the average above or below the true average of the swatch for each the machine and cross-machine direction, respectively. Determine the number of specimens as follows:

8.1.1.1 *Reliable Estimate of v* —When there is a reliable estimate of v based upon extensive past records for similar



a. Photograph of Foil Steam Gauges.
Note one is Attached to Geotextile.

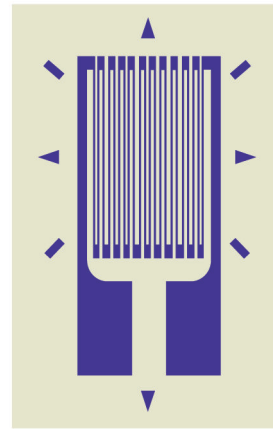

b. Schematic Diagram of Foil Strain Gauge Used for Monitoring.

FIG. 7 Foil Strain Gauges

materials tested in the user’s laboratory as directed in the method, calculate the required number of specimens using Eq 1, as follows:

$$n = (tv/A)^2 \quad (1)$$

where:

- n = number of specimens (rounded upward to a whole number),
- v = reliable estimate of the coefficient of variation of individual observations on similar materials in the user’s laboratory under conditions of single-operator precision, %,
- t = the value of Student’s t for one-sided limits (see Table 1), a 95 % probability level, and the degrees of freedom associated with the estimate of v , and
- A = 5.0 % of the average, the value of the allowable variation.

8.1.1.2 *No Reliable Estimate of v* —When there is no reliable estimate of v for the user’s laboratory, Eq 1 should not be used directly. Instead, specify the fixed number of six specimens for each the machine direction and the cross-machine direction tests. The number of specimens is calculated using $v = 7.4$ % of the average. This value for v is somewhat larger than usually found in practice. When a reliable estimate of v for the user’s laboratory becomes available, Eq 1 will usually require fewer than the fixed number of specimens.

8.2 *Test Specimen Size:*

8.2.1 Prepare each finished specimen 200 mm [8.0 in.] wide (excluding fringe when applicable, see 8.2.2) by at least 200 mm [8.0 in.] long (see 8.2.2) with the length dimension being designated and accurately parallel to the direction for which the tensile strength is being measured. If necessary, centrally, draw two lines running the full width of the specimen, accurately perpendicular to the length dimension and separated by 100 mm [4 in.] to designate the gage area (see 5.4.1 and Note 6).

TABLE 1 Values of Student’s t for One-Sided Limits and the 95 % Probability^A

| df | One-Sided | df | One-Sided | df | One-Sided |
|----|-----------|----|-----------|-----|-----------|
| 1 | 6.314 | 11 | 1.796 | 22 | 1.717 |
| 2 | 2.920 | 12 | 1.782 | 24 | 1.711 |
| 3 | 2.353 | 13 | 1.771 | 26 | 1.706 |
| 4 | 2.132 | 14 | 1.761 | 28 | 1.701 |
| 5 | 2.015 | 15 | 1.753 | 30 | 1.697 |
| 6 | 1.943 | 16 | 1.746 | 40 | 1.684 |
| 7 | 1.895 | 17 | 1.740 | 50 | 1.676 |
| 8 | 1.860 | 18 | 1.734 | 60 | 1.671 |
| 9 | 1.833 | 19 | 1.729 | 120 | 1.658 |
| 10 | 1.812 | 20 | 1.725 | ∞ | 1.645 |

^A Values in this table were calculated using Hewlett Packard HP 67/97 Users’ Library Programs 03848D, “One-Sided and Two-Sided Critical Values of Student’s t ” and 00350D, “Improved Normal and Inverse Distribution.” For values at other than the 95 % probability level, see published tables of critical values of Student’s t in any standard statistical text. Further use of this table is defined in Practice D2905.

8.2.2 For some woven geotextiles, it may be necessary to cut each specimen 210 mm [8.5 in.] wide and then remove an equal number of yarns from each side to obtain the 200 mm [8.0 in.] finished dimension. This helps maintain specimen integrity during the test.

8.2.3 The length of the specimen depends upon the type of clamps being used. It must be long enough to extend through the full length of both clamps, as determined for the direction of test.

8.2.4 When specimen integrity is not affected, the specimens may be initially cut to the finished width.

8.2.5 When the wet tensile strength of the fabric is required in addition to the dry tensile strength, cut each test specimen at least twice as long as is required for a standard test (see Note 1). Number each specimen and then cut it crosswise into two parts, one for determining the conditioned tensile strength and the other for determining the wet tensile strength; each portion shall bear the specimen number. In this manner, each paired break is performed on test specimens containing the same yarns.



NOTE 2—For geotextiles which shrink excessively when wet, cut the test specimens for obtaining wet tensile strength longer in dimension than that for dry tensile strength.

9. Conditioning

9.1 Bring the specimens to moisture equilibrium in the atmosphere for testing geotextiles. Equilibrium is considered to have been reached when the increase in mass of the specimen in successive weighings made at intervals of not less than 2 h does not exceed 0.1 % of the mass of the specimen. In general practice, the industry approaches equilibrium from the “as-received” side.

NOTE 3—It is recognized that in practice, geotextile materials are frequently not weighed to determine when moisture equilibrium has been reached. While such a procedure cannot be accepted in cases of dispute, it may be sufficient in routine testing to expose the material to the standard atmosphere for testing for a reasonable period of time before the specimens are tested. A time of at least 24 h has been found acceptable in most cases. However, certain fibers may exhibit slow moisture equalization rates from the “as-received” wet side. When this is known, a preconditioning cycle as described in Practice D1776/D1776M may be agreed upon between contractual parties.

9.2 Specimens to be tested in the wet condition shall be immersed in water maintained at a temperature of 21 ± 2 °C [70 ± 4 °F]. The time of immersion must be sufficient to wet out the specimens thoroughly, as indicated by no significant change in strength or elongation following a longer period of immersion, and at least 2 min. To obtain thorough wetting, it may be necessary or advisable to add not more than 0.05 % of a nonionic neutral wetting agent to the water.

10. Procedure

10.1 *Conditioned Specimens*—Test adequately conditioned specimens in the atmosphere for testing geotextiles.

10.2 *Wet Specimens*—Test thoroughly wet specimens in the normal machine setup within 20 min after removal from the water.

10.3 *Machine Setup Conditions*—Adjust the distance between the clamps at the start of the test either at 100 ± 3 mm [4 ± 0.1 in.] if not using an extensometer or as far apart to adequately insert an extensometer (see 6.3). At least one clamp should be supported by a free swivel or universal joint, which will allow the clamp to rotate in the plane of the fabric. Select the force range of the testing machine so the break occurs between 10 and 90 % of full-scale force. Set the machine to a strain rate of 10 ± 3 %/min.

NOTE 4—It is recognized that some tensile tests on geotextiles are conducted using a manually applied strain rate. In that case, approximately a 2 %/min strain rate should be used. In any event, the strain rate described in 10.3 is preferred.

10.4 *Insertion of Specimen in Clamps*—Mount the specimen centrally in the clamps. The specimen length in the machine direction and cross-machine direction tests, respectively, must be parallel to the direction of application of force. Extreme care should be used when loading the specimen in the clamps to ensure vertical alignment in the direction of test. A pre-tension force may be applied to the specimen provided it does not exceed 1.0 % of the expected breaking force. Test specimen results with a pre-tension force exceeding 1.0 % of the mea-

sured tensile strength may only be used to determine tensile strength of the sample, and shall be excluded from consideration for load strain (modulus) properties of the sample.

10.5 *Measurement of Tensile Strength*—Start the tensile testing machine and the area-measuring device, if used, and continue running the test to rupture. Stop the machine and reset to the initial gage position. Record and report the test results to three significant figures for each direction separately (see Note 6).

10.5.1 If a specimen slips in the jaws, breaks at the edge of or in the jaws, or if for any reason attributed to faulty operation the result falls markedly below the average for the set of specimens, discard the result and test another specimen. Continue until the required number of acceptable breaks has been obtained. (See 6.2.1.)

10.5.2 The decision to discard the results of a break shall be based on observation of the specimen during the test and upon the inherent variability of the fabric. In the absence of other criteria for rejecting a so-called jaw break, any break occurring within 5 mm [$1/4$ in.] of the jaws which results in a value below 20 % of the average of all the other breaks shall be discarded. No other break shall be discarded unless the test is known to be faulty.

10.5.3 It is difficult to determine the precise reason why certain specimens break near the edge of the jaws. If a jaw break is caused by damage to the specimen by the jaws, then the results should be discarded. If, however, it is merely due to randomly distributed weak places, it is a perfectly legitimate result. In some cases, it may also be caused by a concentration of stress in the area adjacent to the jaws because they prevent the specimen from contracting in width as the force is applied. In these cases, a break near the edge of the jaws is inevitable and shall be accepted as a characteristic of the particular method of test.

10.5.4 For instructions regarding the preparation of specimens made from glass fiber to minimize damage in the jaws, see Specification D579/D579M.

10.5.5 If a geotextile manifests any slippage in the jaws or if more than 24 % of the specimens break at a point within 5 mm [0.25 in.] of the edge of the jaw, then (1) the jaws may be padded, (2) the geotextile may be coated under the jaw face area, or (3) the surface of the jaw face may be modified. If any of the modifications listed above is used, state the method of modification in the report.

10.6 *Measurement of Elongation*—Measure the elongation of the geotextile at any stated force by means of a suitable recording device at the same time as the tensile strength is determined, unless otherwise agreed upon, as provided for in an applicable material specification. Measure the elongation to three significant figures.

10.6.1 A measured strain within the specimen can be obtained from jaw-to-jaw measurements by gaging along the center axis between the jaws across the center 3 in. of the specimen. These measurements can be made using a sealed rule taped on a line on the upper end of the specimen in the gage area, and recording the change in length as measured from a line spaced 3 in. below the upper line. In addition, the center portion of the specimen can be gaged using LVDTs or

mechanical gages. By comparing, it can be determined if slippage is occurring in the clamps.

11. Calculations

11.1 *Tensile Strength*—Calculate the tensile strength of individual specimens, that is, the maximum force per unit width to cause a specimen to rupture as read directly from the testing instrument expressed in N/m [lbf/in.] of width, using Eq 2 as follows:

$$\alpha_f = F_f / W_s \quad (2)$$

where:

α_f = tensile strength, N/m [lbf/in.] of width,
 F_f = observed breaking force, N [lbf], and
 W_s = specified specimen width, m [in.].

11.2 *Elongation*—Calculate the elongation of individual specimens, expressed as the percentage increase in length, based upon the initial nominal gage length of the specimen using Eq 3 for XY-type recorders, or Eq 4 for manual readings (ruler), as follows:

$$\varepsilon_p = (E \times R \times 100) / (C \times L_g) \quad (3)$$

$$\varepsilon_p = (\Delta L \times 100) / L_g \quad (4)$$

where:

ε_p = elongation, %,
 E = distance along the zero-force axis from the point the curve leaves the zero-force axis to a point of corresponding force, mm [in.],
 R = testing speed rate, m/min [in./min],
 C = recording chart speed, m/min [in./min],
 L_g = initial nominal gage length, mm [in.], and
 ΔL = the unit change in length from a zero force to the corresponding measured force, mm [in.].

NOTE 5—Some clamping arrangements may lead to slack in the specimen within the gage area. When this occurs, that increase of the specimen length must be added and included as part of L_g , nominal gage length.

11.3 Tensile Modulus:

11.3.1 *Initial Tensile Modulus*—Determine the location and draw a line tangent to the first straight portion of the force-elongation curve. At any point on this tangent line, measure the force and the corresponding elongation with respect to the zero-force axis. Calculate initial tensile modulus in N/m [lbf/in.] of width using Eq 5 as follows:

$$J_i = (F \times 100) / (\varepsilon_p \times W_s) \quad (5)$$

where:

J_i = initial tensile modulus, N/m [lbf/in.] of width,
 F = determined force on the drawn tangent line, N [lbf],
 ε_p = corresponding elongation with respect to the drawn tangent line and determined force, %, and
 W_s = specimen width, m [in.].

11.3.2 *Offset Tensile Modulus*—Determine the location and draw a line tangent to the force-elongation curve between the tangent point and the proportional limit and through the zero-force axis. Measure the force and the corresponding elongation with respect to the force axis. Calculate offset tensile modulus using Eq 6 (see Fig. X2.1 and Fig. X3.1), as follows:

$$J_o = (F \times 100) / (\varepsilon_p \times W_s) \quad (6)$$

where:

J_o = offset tensile modulus, N/m [lbf/in.] of width,
 F = determined force on the drawn tangent line, N [lbf],
 ε_p = corresponding elongation with respect to the drawn tangent line and determined force, %, and
 W_s = specimen width, m [in.].

11.3.3 *Secant Tensile Modulus*—Determine the force for a specified elongation, ε_2 , usually 10 %, and label that point on the force-elongation curve as P_2 . Likewise, label a second point, P_1 , at a specified elongation, ε_1 , usually 0 % elongation. Draw a straight line (secant) through both points P_1 and P_2 intersecting the zero-force axis. The preferred values are 0 and 10 % elongation, respectively, although other values may be used, for example, when provided for in an applicable material specification. Calculate secant tensile modulus using Eq 7 (see Fig. X3.1) as follows:

$$J_s = (F \times 100) / (\varepsilon_p \times W_s) \quad (7)$$

where:

J_s = secant tensile modulus, N [lbf] between specified elongations per m [in.] of width,
 F = determined force on the constructed line, N [lbf],
 ε_p = corresponding elongation with respect to the constructed line and determined force, %, and
 W_s = specimen width, m [in.].

11.4 Breaking Toughness:

11.4.1 When using the force-elongation curves, draw a line from the point of maximum force of each specimen perpendicular to the elongation axis. Measure the area bounded by the curve, the perpendicular and the elongation axis by means of an integrator or a planimeter, or cut out the area of the chart under the force-elongation curve, weigh it, and calculate the area under the curve using the weight of the unit area.

11.4.2 When determining breaking toughness of geotextiles using a manual gage (steel rule or dial) to measure the amount of strain at a given force, record the change in specimen length for at least ten corresponding force intervals. Approximately equal force increments should be used throughout the application of force having the final measurement taken at specimen rupture.

11.4.3 When determining the breaking toughness of geotextiles that exhibit take-up of slack caused by fabric weave, crimp, or design, the area under the force-elongation curve which precedes the initial modulus line represents the work to remove this slack. Automatic area-measuring equipment may or may not include this area in measuring breaking toughness, and therefore, such information should be reported along with the value observed for the breaking toughness.

11.4.4 Calculate the breaking toughness or work-to-break per unit surface area for each specimen when using XY recorders using Eq 8, or when using automatic area-measuring equipment using Eq 9, or when using manually obtained strain measurements with a steel rule or dial gage using Eq 10:

$$T_u = (A_c \times S \times R) / (W_c \times C \times A_s) \quad (8)$$

$$T_u = (V \times S \times R) / (I_c \times A_s) \quad (9)$$

$$T_u = \sum_0^{F_c} p d \Delta L \quad (10)$$

where:

- T_u = breaking toughness, J/m^2 [in.·lbf/in.²],
- A_c = area under the force-elongation curve, m^2 [in.²],
- S = full-scale force range, N [lbf],
- R = testing speed rate, m/min [in./min],
- W_c = recording chart width, m [in.],
- C = recording chart speed, m/min [in./min],
- A_s = area of the test specimen within the gage length, m^2 [in.²], usually 0.200 m by 0.100 m [8 in. by 4 in.] (see [Note 6](#)),
- V = integrator reading,
- I_c = integrator constant,
- F_f = observed breaking force, N [lbf],
- ΔL = unit change in length from a zero force to the corresponding measured force, mm [in.],
- p = unit stress per area of test specimen within the gage length, N/m^2 [lbf/in.²], and
- 0 = zero force.

11.5 *Average Values*—Calculate the average values for tensile strength, elongation, initial modulus, secant modulus, and breaking toughness of the observations for the individual specimens tested to three significant figures.

12. Report

12.1 Report that the specimens were tested as directed in Test Method D4595/D4595M. Describe the material or product sampled and the method of sampling used.

12.2 Identification and description of geotextile sample, including roll number and lot number.

12.3 Report all of the following applicable items for both the machine direction and cross direction of the material tested.

12.3.1 Average breaking force/unit width in N/m [lbf/in.] as tensile strength and the pre-tension force applied to each specimen as a percentage of the breaking force for that specimen.

12.3.2 Average elongation at specified force in percent.

12.3.3 If requested, the average initial or secant modulus in N/m [lbf/in.]. For secant modulus, state that portion of the force-elongation curve used to determine the modulus, that is, 0 to 10 % elongation, reported as 10 % secant modulus. Other portions of the force-elongation curve can be reported as requested.

12.3.4 If requested, the average breaking toughness (work-to-break per unit surface area) in J/m^2 [in.·lbf/in.²]. Report the method of calculation.

12.3.5 If requested, the standard deviation, coefficient of variation, or both, of any of the properties.

12.3.6 If requested, include a force-elongation curve as part of the report.

12.3.7 Condition of specimen (dry or wet).

12.3.8 Number of specimens tested in each direction.

12.3.9 Make and model of testing machine.

12.3.10 Size of jaw faces used.

12.3.11 Type of padding used in jaws, modification of specimens gripped in the jaws, or modification of jaw faces, if used.

12.3.12 Full-scale force range used for testing.

12.3.13 Any modification of procedure (see [5.2](#)).

13. Precision and Bias ([Note 6](#))⁴

13.1 *Precision*—The precision of this method of testing wide-width strip tensile properties is being established.

13.2 *Bias*—The true value of wide-width strip tensile properties of geotextiles can only be defined in terms of a specific test method. Within this limitation, the procedures in Test Method D4595/D4595M has no known bias.

NOTE 6—The wide-width tensile task group of Subcommittee D35.01 conducted a pilot interlaboratory test in 1985. This test indicated that additional clarification to illustrate implied procedures within the test procedure should be provided. The major problem encountered was definition of the origin (zero position) point on the force-elongation curve. The following procedural interpretations with respect to this test method are suggested: (1) No bonding of the specimen should be provided within the clamp face area for materials showing a breaking force of 17 500 N/m [100 lbf/in.] and under, unless shown to be necessary as agreed upon between the purchaser and supplier; (2) Protection within the clamp faces should be provided, such as resin bonded tabs, for materials having a breaking force in excess of 17 500 N/m [100 lbf/in.]; (3) The gage length should be determined relative to the zero baseline on the extension axis and the applied pre-tension force (zero position point); (4) The zero position point should be used to determine the elongation, initial modulus, and secant modulus when applicable; (5) Roller clamps and other mechanical clamping mechanisms have been successfully used in conjunction with external extensometers, however strain rates may be different compared to flat-faced clamps. The task group is continuing further interlaboratory testing. It is the intent of the task group to include the above-mentioned clarifications and subsequent changes as a result of improved technology in future issues of this test method; (6) Prior to 2017, pre-tension force was limited to 50 lb/ft. When attempting to replicate load strain properties for older projects, specifications, or degradation of load strain properties over time, the user may want to implement that limit.

⁴ Supporting data have been filed at ASTM International Headquarters and may be obtained by requesting Research Report RR:D35-1002. Contact ASTM Customer Service at service@astm.org.

APPENDIXES

(Nonmandatory Information)

X1. EXTENSOMETERS

X1.1 Three types of extensometers have been successfully used in testing geosynthetics.

X1.1.1 Direct reading extensometers are mounted directly on the geosynthetic. These extensometers typically consist of linear variable differential transformer (LVDT) units that read strain directly as the material extends. These units place an additional force (weight) on the material undergoing testing and may have an effect on the force versus strain results. The user should determine that this additional force is or is not significant for the material being tested. Typically, this type of extensometer cannot be used in confined testing.

X1.1.2 Semi-remote reading extensometers use clamps that are mounted directly on the geosynthetic. Wires, pulley systems, or other physical devices connect the clamps to LVDT units. This type of extensometer can be appropriate for

confined testing, but provisions must be provided to protect wires, etc. from influences due to the confinement.

X1.1.3 Remote extensometers (optical) use markers or other devices that are mounted directly on the geosynthetic and sensing units that are mounted independent of the geosynthetic and the markers or devices. These sensing units use electromagnetic radiation, such as light, to sense the distance between the markers. This type of extensometer may be inappropriate for use in confined tests.

X1.2 Users must bear in mind that clamps, markers, or other physical attachments can damage materials undergoing testing. This damage can cause premature failure in geosynthetics. It is of paramount importance to design and use clamps, markers, or other attachments in a manner that will not alter test results by damaging the material undergoing testing.

X2. INITIAL GEOTEXTILE TENSILE MODULUS

X2.1 In a typical force-elongation curve (Fig. X2.1), there is usually a toe region AC that represents take-up of slack, alignment, or seating of the specimen; it can also represent a significant part of the elongation characteristic of the specimen. This region is considered when determining the initial geotextile modulus.

X2.1.1 The initial geotextile tensile modulus can be determined by dividing the force at any point along the line AG (or its extension) by the elongation at the same point (measured from point A, defined as zero strain).

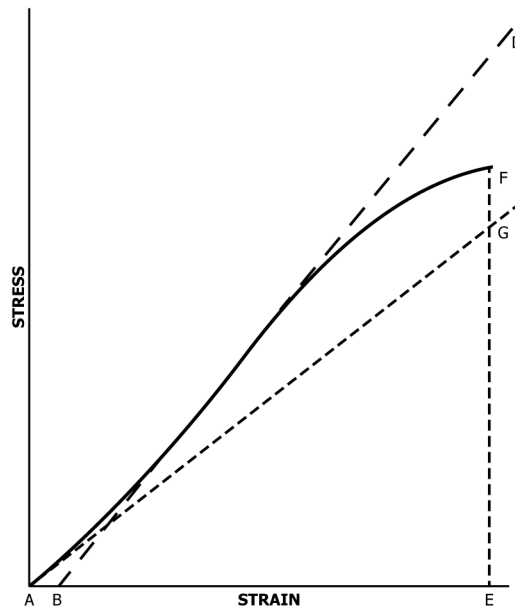

FIG. X2.1 Material with Hookean Region

X3. OFFSET GEOTEXTILE TENSILE MODULUS

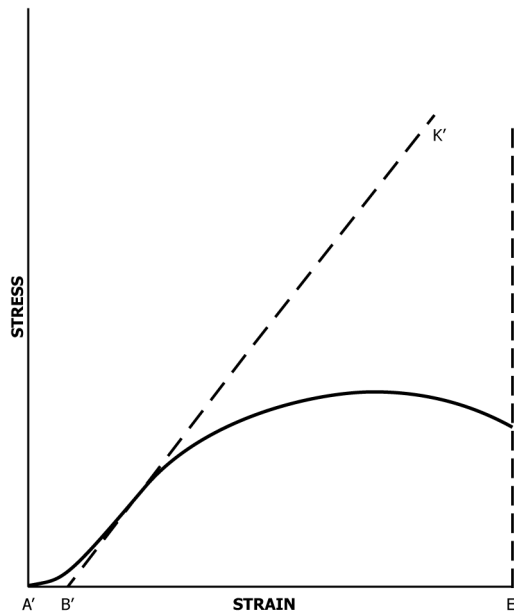

FIG. X3.1 Material with No Hookean Region

X3.1 In the case of a geotextile exhibiting a region of Hookean (linear) behavior (Fig. X2.1) after the nonlinear region, a continuation of the linear region of the curve is constructed through the zero-force axis. This intersection, point *B*, is the zero-elongation point from which elongation is measured.

X3.1.1 The offset geotextile tensile modulus (Fig. X2.1) can be determined by dividing the force at any point along the line *BD* (or its extension) by the strain at the same point (measured from point *B*, defined as zero strain). The point where line *BD* first touches the force-versus-strain curve is the tangent point (for example, *C*).

X3.2 In the case of a geotextile that does not exhibit any linear region (Fig. X3.1), a line is constructed tangent to the point on the force-versus-strain curve exhibiting the maximum slope (that is, point *H*). This is extended to intersect the zero-force axis at point *B'*. This intersection, point *B'*, is the zero-strain point from which strain is measured.

X3.2.1 The offset geotextile tensile modulus can be determined by dividing the force at any point along line *B'K'* (or its extension) by the strain at the same point (measured from point *B'*, defined as zero strain).

X4. SECANT GEOTEXTILE TENSILE MODULUS

X4.1 In a typical force-versus-strain curve (Fig. X4.1), a straight line is constructed through the zero-force axis, usually at zero-strain point *A''* and a second point usually at 10 % strain, point *M''*. Point *A''* is the zero-strain point from which strain is measured.

X4.1.1 The secant geotextile tensile modulus at the selected strain level can be determined by dividing the force at any point along line *A''M''* (or its extension) by the strain at the same point (measured from point *A''*, defined as zero strain).

X4.1.2 Fig. X4.1 also presents a straight line constructed through any two specified points, where a secant modulus is to

be calculated, point *Q''* and point *R''*, other than zero and 10 % strain. In this case, the line is extended through the zero-force axis at point *B''*. This intersection is the zero-strain point from which strain is measured. The secant geotextile tensile modulus can be determined by dividing the force at any point along line *Q''R''* (or its extension) by the strain at the same point (measured from point *B''*, defined as zero strain). If this latter method is used, for example to account for zero-force offset due to the removal of slack, etc. in the geosynthetic, the specified means for defining points *Q''* and *R''* should be identified in the testing report.

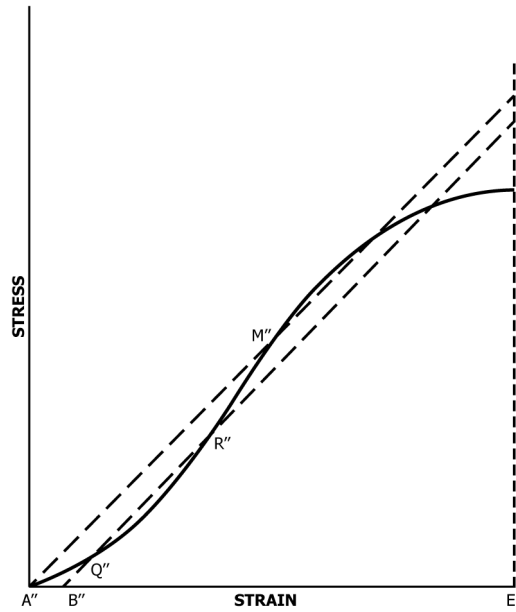

FIG. X4.1 Construction Line for Secant Modulus

X5. WIDE-WIDTH TENSILE TESTING CLAMPING GUIDE

X5.1 See [Table X5.1](#).

TABLE X5.1 Wide-Width Tensile Clamping Guide

NOTE 1—Clamp type guidance is independent of strain measurement procedure and only addresses strength measurement.

NOTE 2—The success in applying individual clamping arrangements is dependent upon successful selection of grip faces and surfacing.

NOTE 3—If failures are cascading failures or jaw breaks, the clamping apparatus needs to be reconsidered or the bond with the clamp re-examined. See [10.5.3](#) for more guidance.

| Clamp Type | Hydraulic Plate | Hydraulic "Smart" (pressure sensitive) | Capstan single wrap | Capstan multi-wrap | Coil Wedge |
|----------------------------------|-----------------|--|---------------------|--------------------|-------------------------|
| Material Type | | | | | |
| High Strength Strap | | x | | | x |
| <1000 lb/in. Nonwoven Geotextile | x | x | | | |
| >1000 lb/in. Nonwoven Geotextile | | x | | | |
| >1000 lb/in. Woven Geotextile | | x | x | | |
| >500 lb/in. Woven Geotextile | | x | x | x | |
| <500 lb/in. Woven Geotextile | x | x | x | x | |
| Glass GG and Meshes | | x | | x | |
| Example | Curtis clamps | Demgen clamps | | | Linear Composite Clamps |



ASTM International takes no position respecting the validity of any patent rights asserted in connection with any item mentioned in this standard. Users of this standard are expressly advised that determination of the validity of any such patent rights, and the risk of infringement of such rights, are entirely their own responsibility.

This standard is subject to revision at any time by the responsible technical committee and must be reviewed every five years and if not revised, either reapproved or withdrawn. Your comments are invited either for revision of this standard or for additional standards and should be addressed to ASTM International Headquarters. Your comments will receive careful consideration at a meeting of the responsible technical committee, which you may attend. If you feel that your comments have not received a fair hearing you should make your views known to the ASTM Committee on Standards, at the address shown below.

This standard is copyrighted by ASTM International, 100 Barr Harbor Drive, PO Box C700, West Conshohocken, PA 19428-2959, United States. Individual reprints (single or multiple copies) of this standard may be obtained by contacting ASTM at the above address or at 610-832-9585 (phone), 610-832-9555 (fax), or service@astm.org (e-mail); or through the ASTM website (www.astm.org). Permission rights to photocopy the standard may also be secured from the Copyright Clearance Center, 222 Rosewood Drive, Danvers, MA 01923, Tel: (978) 646-2600; <http://www.copyright.com/>